

Überbandmagnetscheider Magnetic Overband Separators

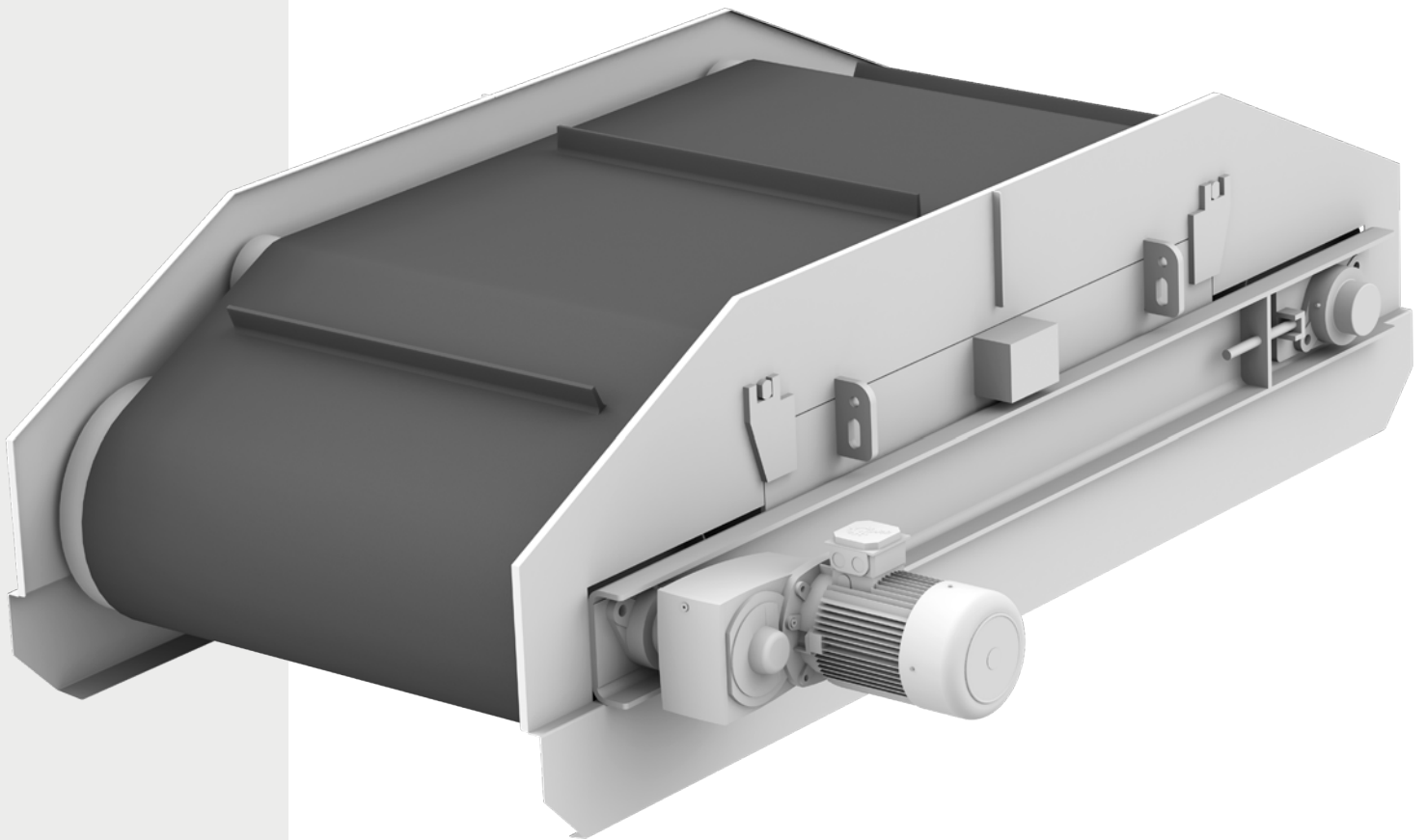

Überbandmagnetscheider *Magnetic overband separators*

Einsatzgebiete

Überbandmagnetscheider werden zur Abscheidung von Fremdeisenteilen aus Schüttgütern aller Art eingesetzt und sind unter anderem bestens geeignet für:

- Rückgewinnung von Eisenteilen aus Schlacken, Haus- und Industriemüll, Formsand, etc.
- Schutz vor Beschädigung durch Fremdeisenteile (Brecher, Mühlen, Förderbänder, Vibrationsrinnen, Schurren, Sieben...)
- Überbandmagnetscheider mit Austragsband werden dort verwendet, wo Fremdeisen laufend anfällt bzw. der Austrag automatisch erfolgen soll
- Austrag ist längs, quer oder in Sonderfällen auch schräg zum Förderband möglich
- Beste Abscheideergebnisse sind physikalisch bedingt bei Längsaustrag gegeben, wenn der Abscheider über der Kopfrolle eines Förderbandes in Bandrichtung angeordnet ist

Range of application

Magnetic overband separators are used to separate tramp iron from any kind of bulk material and are among others ideally suited for:

- *Recover magnetic particles from slag, domestic (MSW) or industrial waste, foundry sand, etc.*
- *Protection from damage through tramp iron (crushers, mills, belts, feeders, chutes, screens, ...)*
- *Magnetic overband separators with discharge belt are used where tramp iron occurs continuously or automatic discharge is required*
- *Inline, cross-belt or in specific cases, diagonal installation is possible*
- *Best separation results are given, when using inline installation above the head pulley of a belt conveyor in longitudinal direction*



Kriterien für die Auswahl *Selection criteria*

Maßgebliche Faktoren

- + Größe, Gewicht und Form der abzuscheidenden Eisenteile
- + Fördergut
- + Förderleistung
- + Korngröße
- + Förderbandgeschwindigkeit



Key factors

- + *Size, weight and shape of the tramp iron to be extracted from the main feed*
- + *Material type*
- + *Capacity*
- + *Particle size*
- + *Belt speed*



Ein sehr starkes, tiefwirkendes Magnetfeld...
A very strong and deep magnetic field...

Elektromagnetische Überbandmagnetscheider *Electromagnetic overband separators*

Aufbau

An der Unterseite einer, durch ein Stahlgehäuse umschlossenen Spule wird ein starkes, tiefreichendes Magnetfeld erzeugt.

Construction

A strong, deep magnetic field is generated on the underside of a coil that is enclosed by a steel housing.



Automatische Austragseinrichtung: (optional)
Von den vier Rollen, die der Austragsgurt (endloser Gummigurt) umläuft, wird eine durch einen Aufsteckgetriebemotor angetrieben. Eine zweite Rolle ist in Spannlagern montiert und dient zum Verstellen des Bandlaufes und der Bandspannung.

Automatic discharge device: (optional)
The discharge belt (endless rubber belt) runs around four pulleys. One pulley is driven by a shaft-mounted geared motor whereas the other pulley is used for adjusting tension and alignment of the belt.

Vorteile

- + Ideal bei großen Aufhängehöhen und hohen Förderleistungen
- + Höchste Magnetzugkräfte bei geringem Energieverbrauch
- + Öl-gekühlte Spule für beste Wärmeableitung
- + Kompakte Konstruktion
- + Tiefwirkendes Magnetfeld
- + Einfache Reinigung durch abschaltbares Magnetfeld

Advantages

- + Ideal for larger suspension heights and high throughputs
- + Ultimate magnetic force with low energy consumption
- + Oil-cooled coil providing best heat dissipation
- + Compact design
- + Deep magnetic field
- + Easy cleaning due to defeatable magnetic field



Permanentmagnetische Überbandmagnetscheider *Permanentmagnetic overband separators*

Aufbau

Ein keramisches Dauermagnetmaterial erzeugt durch seine Spezialanordnung ein starkes, tiefreichendes Magnetfeld.

Construction

Due to its special arrangement, a ceramic permanent magnetic material generates a broad and strong magnetic field.

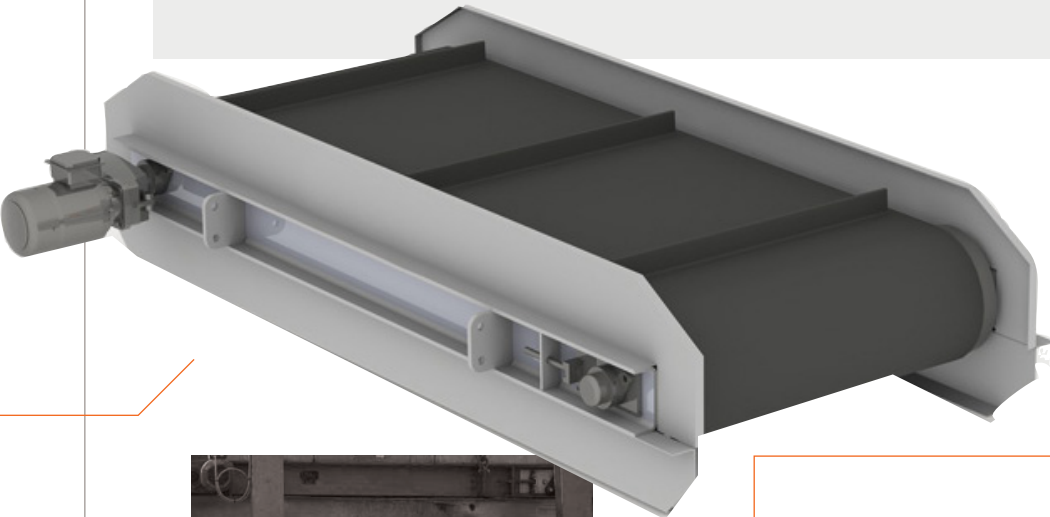

Vorteile

- + Ideal bei niedriger Schicht- bzw. Aufhängehöhe (bis ca. 300 mm)
- + Minimale Betriebskosten
- + Explosionssicher
- + Kein elektrischer Anschluss des Magneten notwendig
- + Kompakte Konstruktion
- + Geringes Gewicht
- + Keine Energiekosten
- + Kurze Amortisationszeiten
- + Unbegrenzte Lebensdauer des Magnetwerkstoffs (Magnetkraftverlust nur 0,5% in 100 Jahren)

Advantages

- + Ideal for lower layers or suspension heights (up to 300 mm)
- + Minimized operating costs
- + Explosion-proof
- + No electric connection of the magnet necessary
- + Compact design
- + Low weight
- + No energy costs
- + Fast payback
- + The ceramic magnetic material is permanently magnetic (loses only 0,5 % of its magnetic force per 100 years)



Standard-Lieferumfang "elektromagnetisch"

- + Magnet mit oder ohne Austragsvorrichtung
- + Schutzart des Magnetkörpers
IP 65 nach DIN 40050
- + Schutzart des Bandantriebsmotors
IP 55 nach DIN 40050
- + Gleichrichter in IP 55 nach DIN 40050
- + Für Bandbreiten von 650 bis 2500 mm
- + Aufhängungen

Standard scope of supply "electromagnetic"

- + Magnet with or without discharge equipment
- + Protection class of the magnet body
IP 65 according to DIN 40050
- + Protection class of the belt drive motor
IP 55 according to DIN 40050
- + Rectifier in IP 55 according to DIN 40050
- + For belt widths from 650 to 2500 mm
- + Suspensions

Standard-Lieferumfang "permanentmagnetisch"

- + Magnet mit oder ohne Austragsvorrichtung
- + Schutzart des Bandantriebsmotors
IP 55 nach DIN 40050
- + Aufhängungen
- + Zusätzlicher Schleißschutz

Standard scope of supply "permanentmagnetic"

- + Magnet with or without discharge equipment
- + Protection class of the belt drive motor
IP 55 according to DIN 40050
- + Suspensions
- + Additional wear protection

Sonderausstattung

- + ATEX-Ausführung (explosionsgeschützt)
- + Sondergurt (z.B. Schuppenband)
- + Externe Kühlung
(nur bei elektromagnetischer Variante)
- + Permanentmagnetische Polverlängerung
- + Schwerlastausführung
- + Diverse Details wie Thermistoren,
Sondermotor, gummierte Rollen,
Drehzahlwächter, Führungsrollen, etc.
- + Weitere permanentmagnetische Typen
verfügbar

Optional features

- + ATEX design (explosion-proof)
- + Special belt (e.g. special protection belt)
- + External cooling
(only with electromagnetic version)
- + Permanentmagnetic extension
- + Heavy-duty design
- + Various details such as thermistors,
special motor, rubberized rollers,
speed monitor, guide rollers, etc.
- + Further permanentmagnetic types
available



Elektromagnetische Überbandmagnetscheider Electromagnetic overband separators

Aushebemagnet "eco line"
Lifting magnet "eco line"

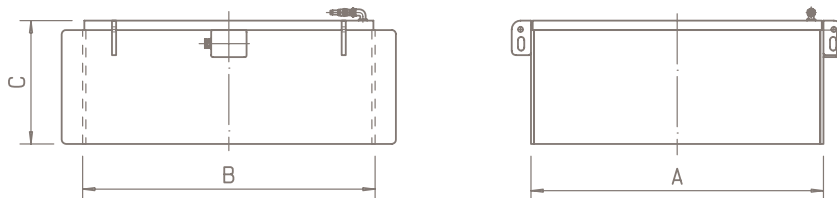

Type Model	Abmessungen Dimensions [mm]			Gewicht Weight [kg]	Magnetleistung ¹⁾ Magnet power ¹⁾ [kW]	Magnetspannung Magnet voltage [V DC]	Max. Förderbandbreite Max. belt width [mm]
	A	B	C				
ME 751 J	750	750	470	800	2,12	115	800
ME 901 L	900	900	490	1100	2,82	115	800
ME 1001 N	1000	1000	495	1400	3,34	115	1000
ME 1101 P	1100	1100	530	1800	4,06	115	1000
ME 1201 Q	1200	1200	565	2400	4,74	115	1200
ME 1401 S	1400	1400	590	3300	6,06	115	1400
ME 1601 T	1600	1600	605	4600	7,56	115	1600
ME 1801 V	1800	1800	645	5700	9,41	230	1800
ME 2001 V	2000	2000	645	8300	11,09	230	2000
ME 2201 V	2200	2200	645	9600	12,77	230	2200
ME 2401 V	2400	2400	685	12100	15,20	230	2400

Einbaurichtlinie Installation guide line

Einbau über Förderband
Installation above belt

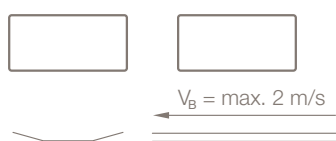

Einbau über Kopfrolle
Installation above head pulley

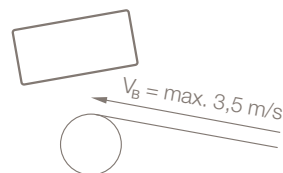

Maximale Neigung
Maximum inclination

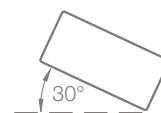

1) HINWEIS: Die Leistung sagt über die absolute Stärke eines elektromagnetischen Abscheiders relativ wenig aus. Wirklich entscheidend ist die sogenannte Amperewindungszahl, also der Aufbau der Magnetspule.

1) NOTE: The power rating says little about the absolute strength of an electromagnetic separator. The so-called ampere coil value is the deciding factor, in other words the design of the magnetic coil.

Elektromagnetische Überbandmagnetscheider Electromagnetic overband separators

Queraustrag oder Längsaustrag "eco line"
Cross-belt or inline "eco line"

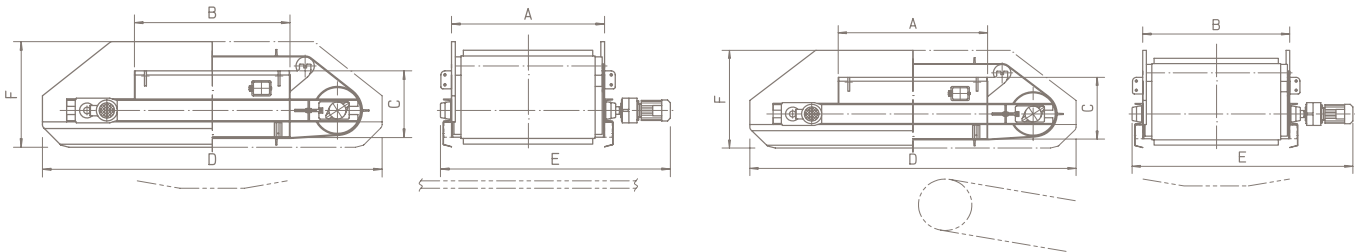

Type Model	Abmessungen Dimensions [mm]						Gewicht Weight [kg]	Magnet- leistung ¹⁾ Magnet power ¹⁾ [kW]	Magnet- spannung Magnet voltage [V DC]	Motor- leistung ²⁾ Drive power ²⁾ [kW]	Austrags- geschwindigkeit V_A ³⁾ Carry-off speed V_A ³⁾ [m/s]	Max. Förder- bandbreite Max. belt width [mm]
	A	B	C	D	E	F						
MEQL 751 J	750	750	470	2000	1400	810	1100	2,12	115	1,5	1,8	800
MEQL 901 L	900	900	490	2150	1550	820	1500	2,82	115	2,2	1,8	800
MEQL 1001 N	1000	1000	495	2400	1700	820	1900	3,34	115	2,2	1,8	1000
MEQL 1101 P	1100	1100	530	2500	1800	850	2300	4,06	115	2,2	1,8	1000
MEQL 1201 Q	1200	1200	565	2650	1900	900	3000	4,74	115	2,2	1,8	1200
MEQL 1401 S	1400	1400	590	3150	2250	980	4500	6,06	115	4,0	1,8	1400
MEQL 1601 T	1600	1600	605	3300	2400	990	5700	7,56	115	4,0	1,8	1600
MEQL 1801 V	1800	1800	645	3500	2700	1030	7200	9,41	230	5,5	1,8	1800
MEQL 2001 V	2000	2000	645	3700	2850	1030	9300	11,09	230	5,5	1,8	2000
MEQL 2201 V	2200	2200	645	3900	3050	1030	10800	12,77	230	7,5	1,8	2200
MEQL 2401 V	2400	2400	685	4250	3250	1180	13500	15,20	230	11,0	1,8	2400

Einbauanleitung Installation guide line

Linksaustrag
Cross-belt to the left

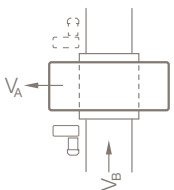

$V_A = 1,8 \text{ m/s}$
 $V_B = \text{max. } 2 \text{ m/s}$

Rechtsaustrag
Cross-belt to the right

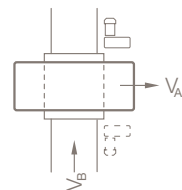

Längsaustrag
Inline

$V_A = 1,1 \times V_B \geq 1,8 \text{ m/s}$
 $V_B = \text{max. } 3,5 \text{ m/s}$

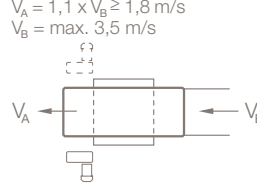

Maximale Neigung
Maximum inclination

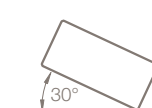

- 1) HINWEIS: Die Leistung sagt über die absolute Stärke eines elektromagnetischen Abscheiders relativ wenig aus. Wirklich entscheidend ist die sogenannte Amperewindungszahl, also der Aufbau der Magnetspule.
- 2) angegebene Motorleistung = Mindestmotorleistung
- 3) Standardaustragsgeschwindigkeit

- 1) NOTE: The power rating says little about the absolute strength of an electromagnetic separator. The so-called ampere coil value is the deciding factor, in other words the design of the magnetic coil.
- 2) stated drive power = minimum power
- 3) standard belt speed

Elektromagnetische Überbandmagnetscheider Electromagnetic overband separators

Aushebemagnet "classic line"
Lifting magnet "classic line"

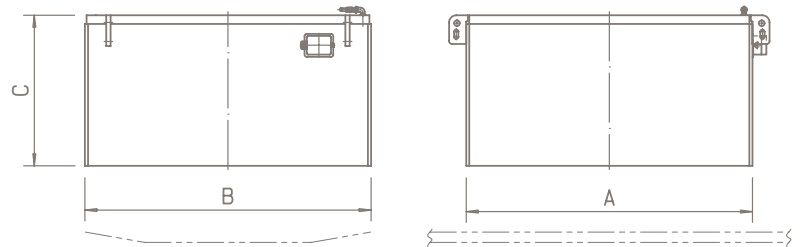

Type Model	Abmessungen Dimensions [mm]			Gewicht Weight [kg]	Magnetleistung ¹⁾ Magnet power ¹⁾ [kW]	Magnetspannung Magnet voltage [V DC]	Max. Förderbandbreite Max. belt width [mm]
	A	B	C				
ME 600 H	920	620	558	750	2,23	115	650
ME 600 J	920	620	558	850	2,32	115	650
ME 750 K	920	770	583	950	2,62	115	800
ME 750 L	920	770	583	1100	2,75	115	800
ME 900 M	920	920	613	1200	3,25	115	800
ME 900 N	920	920	613	1400	3,39	115	800
ME 1000 O	1000	1000	635	1600	4,04	115	1000
ME 1000 P	1000	1000	635	1750	4,12	115	1000
ME 1100 Q	1100	1100	670	2220	4,85	115	1000
ME 1100 R	1100	1100	670	2300	5,06	115	1000
ME 1200 R	1400	1200	700	2900	5,75	115	1200
ME 1200 T	1400	1200	700	3200	6,20	115	1200
ME 1400 S	1600	1400	735	3900	7,65	115	1400
ME 1400 V	1600	1400	735	4400	7,56	230	1400
ME 1600 T	1800	1600	756	5300	9,26	230	1600
ME 1600 V	1800	1600	756	5700	9,26	230	1600
ME 1800 U	2000	1800	806	7250	11,40	230	1800
ME 1800 X	2000	1800	806	7800	11,20	230	1800
ME 2000 Z	2200	2000	1035	12500	15,93	230	2000
ME 2200 Z	2400	2200	1150	15850	17,57	230	2200
ME 2500 Z	2500	2500	1150	18000	20,20	230	2500

Einbaurichtlinie Installation guide line

Einbau über Förderband
Installation above belt

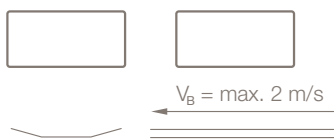

Einbau über Kopfrolle
Installation above head pulley

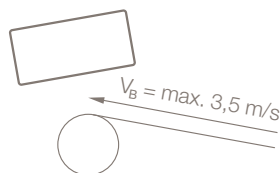

Maximale Neigung
Maximum inclination

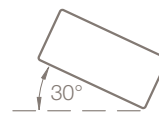

1) HINWEIS: Die Leistung sagt über die absolute Stärke eines elektromagnetischen Abscheiders relativ wenig aus. Wirklich entscheidend ist die sogenannte Amperewindungszahl, also der Aufbau der Magnetspule.

1) NOTE: The power rating says little about the absolute strength of an electromagnetic separator. The so-called ampere coil value is the deciding factor, in other words the design of the magnetic coil.

Elektromagnetische Überbandmagnetscheider Electromagnetic overband separators

Längsausstrag "classic line"
Inline "classic line"

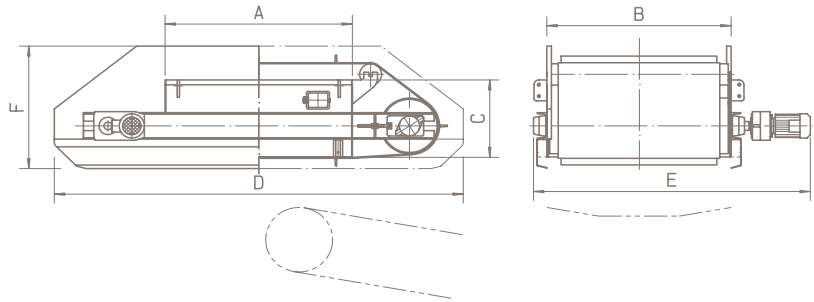

Type Model	Abmessungen Dimensions [mm]						Gewicht Weight [kg]	Magnet- leistung ¹⁾ Magnet power ¹⁾ [kW]	Magnet- spannung Magnet voltage [V DC]	Motor- leistung ²⁾ Drive power ²⁾ [kW]	Austrags- geschwindigkeit $V_A^{3)}$ Carry-off speed $V_A^{3)}$ [m/s]	Max. Förder- bandbreite Max. belt width [mm]
	A	B	C	D	E	F						
MEL 600 H	920	620	558	2500	1250	890	1150	2,23	115	1,5	1,8	650
MEL 600 J	920	620	558	2500	1250	890	1200	2,32	115	1,5	1,8	650
MEL 750 K	920	770	583	2500	1400	920	1350	2,62	115	1,5	1,8	800
MEL 750 L	920	770	583	2500	1400	920	1400	2,75	115	1,5	1,8	800
MEQL 900 M	920	920	613	2550	1700	970	1800	3,25	115	2,2	1,8	800
MEQL 900 N	920	920	613	2550	1700	970	1900	3,39	115	2,2	1,8	800
MEQL 1000 O	1000	1000	635	2600	1750	990	2200	4,04	115	2,2	1,8	1000
MEQL 1000 P	1000	1000	635	2600	1750	990	2300	4,12	115	2,2	1,8	1000
MEQL 1100 Q	1100	1100	670	2700	1850	1020	2800	4,85	115	2,2	1,8	1000
MEQL 1100 R	1100	1100	670	2700	1850	1020	2900	5,06	115	2,2	1,8	1000
MEL 1200 R	1400	1200	700	3020	1950	1050	3700	5,75	115	2,2	1,8	1200
MEL 1200 T	1400	1200	700	3020	1950	1050	3800	6,20	115	2,2	1,8	1200
MEL 1400 S	1600	1400	735	3600	2250	1140	5300	7,65	115	4,0	1,8	1400
MEL 1400 V	1600	1400	735	3600	2250	1140	6000	7,56	230	4,0	1,8	1400
MEL 1600 T	1800	1600	756	3800	2450	1160	6600	9,26	230	4,0	1,8	1600
MEL 1600 V	1800	1600	756	3800	2450	1160	7300	9,26	230	4,0	1,8	1600
MEL 1800 U	2000	1800	806	4000	2650	1210	8600	11,40	230	5,5	1,8	1800
MEL 1800 X	2000	1800	806	4000	2650	1210	9700	11,20	230	5,5	1,8	1800
MEL 2000 Z	2200	2000	1035	4500	2900	1500	17000	15,93	230	5,5	1,8	2000
MEL 2200 Z	2400	2200	1150	5000	3100	1600	21600	17,57	230	7,5	1,8	2200
MEL 2500 Z	2500	2500	1150	6100	3400	1700	28000	20,20	230	11,0	1,8	2500

Einbaurichtlinie Installation guide line

Längsausstrag
Inline

$$V_A = 1,1 \times V_B \geq 1,8 \text{ m/s}$$

$$V_B = \text{max. } 3,5 \text{ m/s}$$

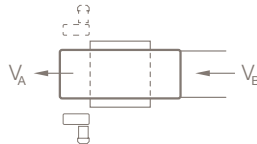

Maximale Neigung
Maximum inclination

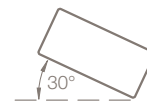

- 1) HINWEIS: Die Leistung sagt über die absolute Stärke eines elektromagnetischen Abscheiders relativ wenig aus. Wirklich entscheidend ist die sogenannte Amperewindungszahl, also der Aufbau der Magnetspule.
- 2) angegebene Motorleistung = Mindestmotorleistung
- 3) Standardaustragsgeschwindigkeit

- 1) NOTE: The power rating says little about the absolute strength of an electromagnetic separator. The so-called ampere coil value is the deciding factor, in other words the design of the magnetic coil.
- 2) stated drive power = minimum power
- 3) standard belt speed

Elektromagnetische Überbandmagnetscheider Electromagnetic overband separators

Queraustrag "classic line"
Cross-belt "classic line"

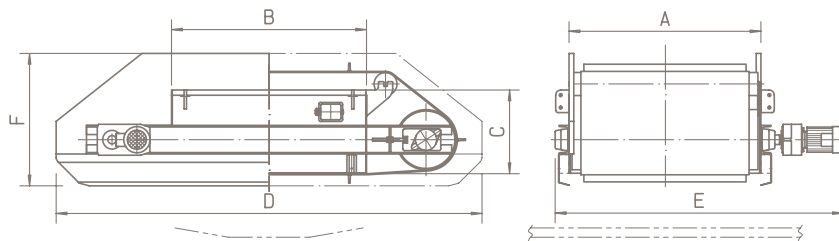

Type Model	Abmessungen Dimensions [mm]						Gewicht Weight [kg]	Magnet- leistung ¹⁾ Magnet power ¹⁾ [kW]	Magnet- spannung Magnet voltage [V DC]	Motor- leistung ²⁾ Drive power ²⁾ [kW]	Austrags- geschwindigkeit $V_A^{3)}$ Carry-off speed $V_A^{3)}$ [m/s]	Max. Förder- bandbreite Max. belt width [mm]
	A	B	C	D	E	F						
MEQ 600 H	920	620	558	2200	1500	890	1200	2,23	115	1,5	1,8	650
MEQ 600 J	920	620	558	2200	1500	890	1300	2,32	115	1,5	1,8	650
MEQ 750 K	920	770	583	2400	1500	920	1300	2,62	115	1,5	1,8	800
MEQ 750 L	920	770	583	2400	1500	920	1500	2,75	115	1,5	1,8	800
MEQL 900 M	920	920	613	2550	1700	970	1800	3,25	115	2,2	1,8	800
MEQL 900 N	920	920	613	2550	1700	970	1900	3,39	115	2,2	1,8	800
MEQL 1000 O	1000	1000	635	2600	1750	990	2200	4,04	115	2,2	1,8	1000
MEQL 1000 P	1000	1000	635	2600	1750	990	2300	4,12	115	2,2	1,8	1000
MEQL 1100 Q	1100	1100	670	2700	1850	1020	2800	4,85	115	2,2	1,8	1000
MEQL 1100 R	1100	1100	670	2700	1850	1020	2900	5,06	115	2,2	1,8	1000
MEQ 1200 R	1400	1200	700	3200	2250	1100	3400	5,75	115	2,2	1,8	1200
MEQ 1200 T	1400	1200	700	3200	2250	1100	4500	6,20	115	2,2	1,8	1200
MEQ 1400 S	1600	1400	735	3400	2450	1140	5300	7,65	115	4,0	1,8	1400
MEQ 1400 V	1600	1400	735	3400	2450	1140	6300	7,56	230	4,0	1,8	1400
MEQ 1600 T	1800	1600	756	3600	2650	1160	6600	9,26	230	4,0	1,8	1600
MEQ 1600 V	1800	1600	756	3600	2650	1160	7200	9,26	230	4,0	1,8	1600
MEQ 1800 U	2000	1800	806	3800	2950	1210	8600	11,40	230	5,5	1,8	1800
MEQ 1800 X	2000	1800	806	3800	2950	1210	9700	11,20	230	5,5	1,8	1800
MEQ 2000 Z	2200	2000	1035	4300	3200	1450	17000	15,93	230	7,5	1,8	2000
MEQ 2200 Z	2400	2200	1150	4700	3400	1600	21600	17,57	230	7,5	1,8	2200
MEQ 2500 Z	2500	2500	1150	6100	3700	1700	28000	20,20	230	11,0	1,8	2500

Einbaurichtlinie Installation guide line

Linksaustrag
Cross-belt to the left

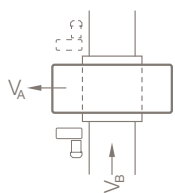

$V_A = 1,8 \text{ m/s}$
 $V_B = \text{max. } 2 \text{ m/s}$

Rechsaustrag
Cross-belt to the right

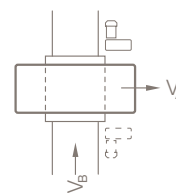

Maximale Neigung
Maximum inclination



- HINWEIS: Die Leistung sagt über die absolute Stärke eines elektromagnetischen Abscheiders relativ wenig aus. Wirklich entscheidend ist die sogenannte Amperewindungszahl, also der Aufbau der Magnetspule.
- angegebene Motorleistung = Mindestmotorleistung
- Standardaustragsgeschwindigkeit

- NOTE: The power rating says little about the absolute strength of an electromagnetic separator. The so-called ampere coil value is the deciding factor, in other words the design of the magnetic coil.
- stated drive power = minimum power
- standard belt speed

Elektromagnetische Überbandmagnetscheider Electromagnetic overband separators

Rechteckmagnet Quer- oder Längsaus trag
Rectangle magnet cross-belt or inline

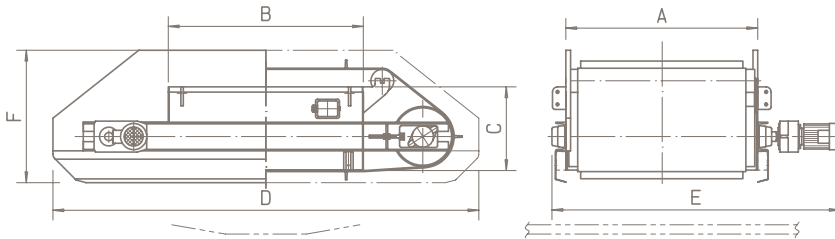

Type Model	Abmessungen Dimensions [mm]						Gewicht Weight [kg]	Magnet- leistung ¹⁾ Magnet power ¹⁾ [kW]	Magnet- spannung Magnet voltage [V DC]	Motor- leistung ²⁾ Drive power ²⁾ [kW]	Austrags- geschwindigkeit $V_A^3)$ Carry-off speed $V_A^3)$ [m/s]	Max. Förder- bandbreite Max. belt width [mm]
	A	B	C	D	E	F						
MEQL 0914 P	900	1400	680	2850	1600	1000	4260	4,83	115	2,2	1,8	900–1400
MEQL 1016 R	1000	1600	750	3050	1750	1100	6000	5,60	230	4,0	1,8	1000–1600
MEQL 1218 T	1200	1800	750	3500	2000	1050	6500	6,40	230	4,0	1,8	1200–1800
MEQL 1222 Q	1200	2200	750	3900	2000	1050	8000	8,40	230	4,0	1,8	1200–2200
MEQL 1625 V	1600	2500	850	4300	2500	1250	12000	12,60	230	7,5	1,8	1600–2500

Einbaurichtlinie Installation guide line

Linksaustrag
Cross-belt to the left

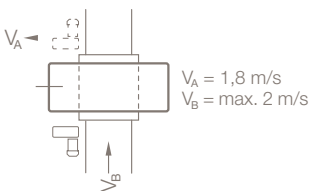

Rechtsaustrag
Cross-belt to the right

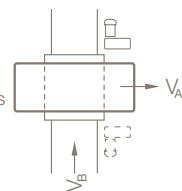

Längsaus trag
Inline

$$V_A = 1,1 \times V_B \geq 1,8 \text{ m/s}$$

$$V_B = \text{max. } 3,5 \text{ m/s}$$

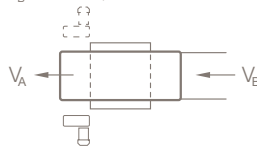

Schrägaus trag
Diagonal installation

$$V_A = 1,2 \times V_B \geq 1,8 \text{ m/s}$$

$$V_B = \text{max. } 3 \text{ m/s}$$

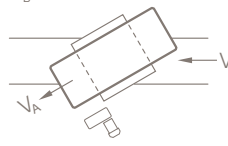

Maximale Neigung
Maximum inclination

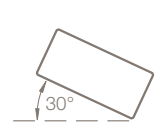

- 1) HINWEIS: Die Leistung sagt über die absolute Stärke eines elektromagnetischen Abscheiders relativ wenig aus. Wirklich entscheidend ist die sogenannte Amperewindungszahl, also der Aufbau der Magnetspule.
- 2) angegebene Motorleistung = Mindestmotorleistung
- 3) Standardaustragsgeschwindigkeit

- 1) NOTE: The power rating says little about the absolute strength of an electromagnetic separator. The so-called ampere coil value is the deciding factor, in other words the design of the magnetic coil.
- 2) stated drive power = minimum power
- 3) standard belt speed

Permanentmagnetische Überbandmagnetscheider Permanentmagnetic overband separators

Aushebemagnet
Lifting magnet

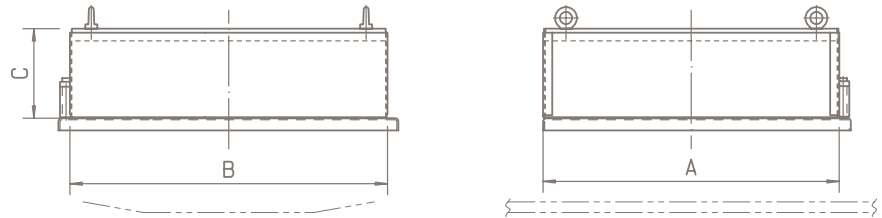

Type Model	Abmessungen Dimensions [mm]			Gewicht Weight [kg]	Max. Förderbandbreite Max. belt width [mm]
	A	B	C		
MP 450 C	530	470	178	230	500
MP 600 C	530	630	178	300	650
MP 600 F	790	630	265	620	650
MP 750 C	530	780	178	385	800
MP 750 F	790	780	265	800	800
MP 750 J	1075	780	353	1120	800
MP 900 C	530	940	178	450	1000
MP 900 F	790	940	265	920	1000
MP 900 J	1075	940	353	1600	1000
MP 900 M	1340	940	440	2280	1000
MP 1100 F	790	1090	265	1100	1200
MP 1100 J	1075	1090	353	1880	1200
MP 1100 M	1340	1090	440	2750	1200
MP 1300 F	790	1250	265	1180	1400
MP 1300 J	1075	1250	353	2120	1400
MP 1300 M	1340	1250	440	3300	1400
MP 1500 J	1075	1560	353	2500	1600
MP 1500 M	1340	1560	440	3820	1600
MP 1700 J	1075	1710	353	2680	1800
MP 1700 M	1340	1710	440	4200	1800
MP 1900 J	1075	1870	353	3150	2000
MP 1900 M	1340	1870	440	4800	2000

Einbaurichtlinie Installation guide line

Einbau über Förderband
Installation above belt

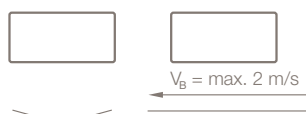

Einbau über Kopfrolle
Installation above head pulley

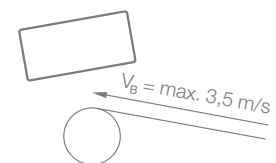

Permanentmagnetische Überbandmagnetscheider Permanentmagnetic overband separators

Längsausstrag
Inline

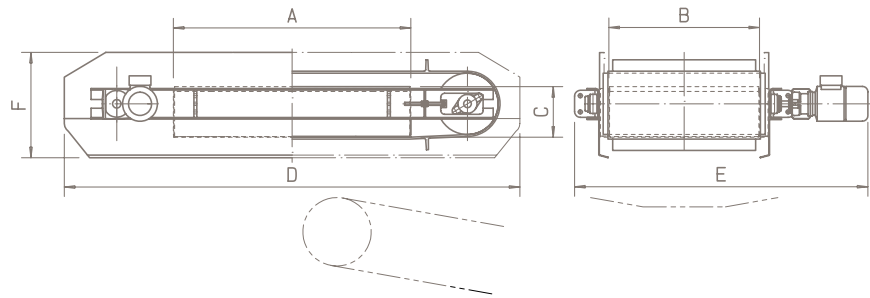

Type Model	Abmessungen Dimensions [mm]						Gewicht Weight [kg]	Motor- leistung ¹⁾ Drive power ¹⁾ [kW]	Austrags- geschwindigkeit $V_A^{2)}$ Carry-off speed $V_A^{2)}$ [m/s]	Max. Förder- bandbreite Max. belt width [mm]
	A	B	C	D	E	F				
MPL 450 C	530	470	178	1600	1300	450	450	1,5	1,8	500
MPL 600 C	530	630	178	1600	1450	450	500	1,5	1,8	650
MPL 600 F	790	630	265	2000	1450	560	900	1,5	1,8	650
MPL 750 C	530	780	178	1600	1600	450	550	1,5	1,8	800
MPL 750 F	790	780	265	2000	1600	560	1050	1,5	1,8	800
MPL 750 J	1075	780	353	2500	1600	640	1650	2,2	1,8	800
MPL 900 C	530	940	178	1600	1950	450	650	1,5	1,8	1000
MPL 900 F	790	940	265	2000	1950	560	1300	2,2	1,8	1000
MPL 900 J	1075	940	353	2500	1950	640	1850	2,2	1,8	1000
MPL 900 M	1340	940	440	3100	1950	730	3700	4,0	1,8	1000
MPL 1100 F	790	1090	265	2000	2150	560	1500	2,2	1,8	1200
MPL 1100 J	1075	1090	353	2500	2150	640	2500	2,2	1,8	1200
MPL 1100 M	1340	1090	440	3100	2150	730	4100	4,0	1,8	1200
MPL 1300 F	790	1250	265	2000	2350	560	1800	2,2	1,8	1400
MPL 1300 J	1075	1250	353	2500	2350	640	2600	2,2	1,8	1400
MPL 1300 M	1340	1250	440	3100	2350	730	4600	4,0	1,8	1400
MPL 1500 J	1075	1560	353	2500	2600	640	3600	4,0	1,8	1600
MPL 1500 M	1340	1560	440	3100	2600	730	5400	4,0	1,8	1600
MPL 1700 J	1075	1710	353	2500	2800	640	4000	4,0	1,8	1800
MPL 1700 M	1340	1710	440	3100	2800	730	5900	4,0	1,8	1800
MPL 1900 J	1075	1870	353	2500	3000	640	4400	4,0	1,8	2000
MPL 1900 M	1340	1870	440	3100	3000	730	6400	4,0	1,8	2000

Einbaurichtlinie Installation guide line

Längsausstrag
Inline

$$V_A = 1,1 \times V_B \geq 1,8 \text{ m/s}$$

$$V_B = \text{max. } 3,5 \text{ m/s}$$

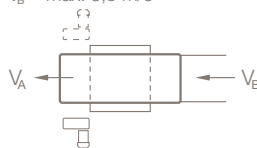

1) angegebene Motorleistung = Mindestmotorleistung
2) Standardaustragsgeschwindigkeit

1) stated drive power = minimum power
2) standard belt speed

Permanentmagnetische Überbandmagnetscheider Permanentmagnetic overband separators

Queraustrag
Cross-belt

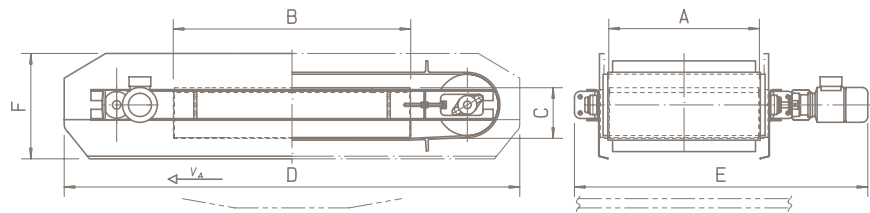

Type Model	Abmessungen Dimensions [mm]						Gewicht Weight [kg]	Motor- leistung ¹⁾ Drive power ¹⁾ [kW]	Austrags- geschwindigkeit $V_A^{2)}$ Carry-off speed $V_A^{2)}$ [m/s]	Max. Förder- bandbreite ³⁾ Max. belt width ³⁾ [mm]
	A	B	C	D	E	F				
MPQ 450 C	530	470	178	1370	1500	450	450	1,5	1,8	500
MPQ 600 C	530	630	178	1520	1500	450	500	1,5	1,8	650
MPQ 600 F	790	630	265	1770	1700	560	950	1,5	1,8	650
MPQ 750 C	530	780	178	1690	1500	450	600	1,5	1,8	800
MPQ 750 F	790	780	265	1940	1700	560	1100	1,5	1,8	800
MPQ 750 J	1075	780	353	2040	2100	640	1850	2,2	1,8	800
MPQ 900 C	530	940	178	1830	1500	450	700	1,5	1,8	1000
MPQ 900 F	790	940	265	2080	1700	560	1250	2,2	1,8	1000
MPQ 900 J	1075	940	353	2200	2100	640	2000	2,2	1,8	1000
MPQ 900 M	1340	940	440	2700	2540	730	3600	4,0	1,8	1000
MPQ 1100 F	790	1090	265	2250	1700	560	1400	2,2	1,8	1200
MPQ 1100 J	1075	1090	353	2580	2100	640	2500	2,2	1,8	1200
MPQ 1100 M	1340	1090	440	2860	2540	730	4150	4,0	1,8	1200
MPQ 1300 F	790	1250	265	2700	1700	560	1550	2,2	1,8	1400
MPQ 1300 J	1075	1250	353	2730	2100	640	2800	2,2	1,8	1400
MPQ 1300 M	1340	1250	440	3020	2540	730	4550	4,0	1,8	1400
MPQ 1500 J	1075	1560	353	3040	2100	640	3350	4,0	1,8	1600
MPQ 1500 M	1340	1560	440	3330	2540	730	5400	4,0	1,8	1600
MPQ 1700 J	1075	1710	353	3180	2100	640	5300	4,0	1,8	1800
MPQ 1700 M	1340	1710	440	3480	2540	730	5800	4,0	1,8	1800
MPQ 1900 J	1075	1870	353	3350	2100	640	5800	4,0	1,8	2000
MPQ 1900 M	1340	1870	440	3640	2540	730	6300	4,0	1,8	2000

Einbaurichtlinie Installation guide line

Linksaustrag
Cross-belt to the left

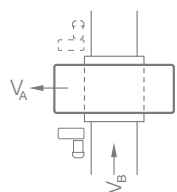

$V_A = 1,8 \text{ m/s}$
 $V_B = \text{max. } 2 \text{ m/s}$

Rechtsaustrag
Cross-belt to the right

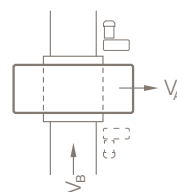

Maximale Neigung
Maximum inclination



1) angegebene Motorleistung = Mindestmotorleistung
2) Standardaustragsgeschwindigkeit
3) gilt für gemuldete Bänder

1) stated drive power = minimum power
2) standard belt speed
3) valid for troughed belts



engagiert
committed



IFE
Material Handling



kompetent
competent



erfahren
experienced



partnerschaftlich
partnership

DER ORANGE WEG IN DIE ZUKUNFT *THE ORANGE WAY INTO THE FUTURE*

IFE hat eine Geschichte, hat Tradition. Wir forschen, entwickeln weiter, sammeln Erfahrungen, arbeiten engagiert, liefern höchste Qualität und stehen zu unserem Wort.

Doch all das wäre nichts wert – ohne UNSERE KUNDEN!

IFE has a history, has a tradition. We explore, develop, collect experiences, work hard, deliver highest quality and keep our promises.

But all that would be worth nothing – without OUR CUSTOMERS!



PurePrint®
innovated by gugler* DruckSinn
Healthy. Residue-free. Climate-positive.
drucksinn.at



– produced according to the guidelines of the Austrian
Eco-label, Gugler GmbH, UW-Nr. 609, www.gugler.at



IFE Aufbereitungstechnik GmbH

Patertal 20
3340 Waidhofen/Ybbs
Austria

Telefon Phone
+43 7442 515-0

Fax Fax
+43 7442 515-15

Mail Mail
office@ife-bulk.com



www.ife-bulk.com